

Yazoo 2

Activity Book

Unit	Page	Unit	Page
Alphabet Aa–Zz	2	7a There's a town.	48
Numbers 1–20	4	7b Where's Chatter?	50
Colours	5	7c Skills: My town	52
1a It's a school!	6	8a She can sing.	54
1b Spell 'octopus'.	8	8b Can you skip?	56
1c Skills: My classroom	10	8c Story: Where's my mobile phone?	58
2a Cars and dolls	12	Science	60
2b That's a robot!	14	Review 4	61
2c Story: The frogs!	16	9a We like breakfast.	62
Social Science	18	9b Patty likes fish.	64
Review 1	19	9c Skills: What's on the menu?	66
3a She's pretty.	20	10a He gets up at seven o'clock.	68
3b Is he your grandpa?	22	10b Does Rob go to the zoo every day?	70
3c Skills: My family	24	10c Story: Superboy!	72
4a We're cowboys.	26	Social Science	74
4b Are we pirates?	28	Review 5	75
4c Story: The grey duck	30	11a I'm playing a game.	76
Maths	32	11b They're having a shower.	78
Review 2	33	11c Skills: Me and my friends	80
5a It's his kite.	34	12a They aren't swimming.	82
5b They're our toys.	36	12b Are they sleeping?	84
5c Skills: Our favourite toys	38	12c Story: Jane and the giant	86
6a She's got a pet.	40	Social Science	88
6b Has it got wings?	42	Review 6	89
6c Story: Sam, the circus boy!	44	My Picture Dictionary	90
Science	46	Cut outs	99
Review 3	47		

1 Look and circle.

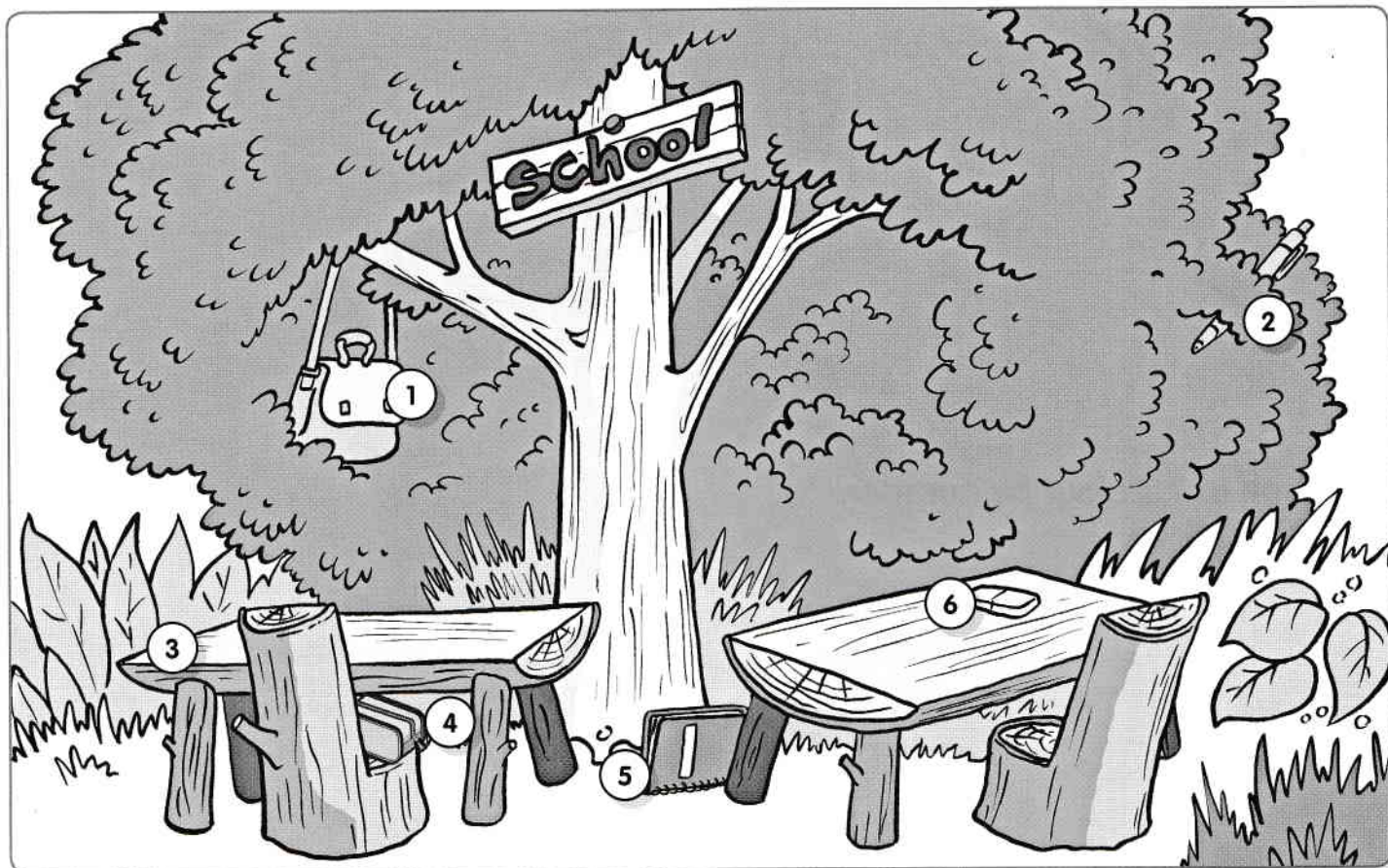

What's this?

- 1 It's a bag / pencil case.
- 2 It's a rubber / pen.
- 3 It's a desk / bag.
- 4 It's a pencil case / pencil.
- 5 It's a notebook / pencil case.
- 6 It's a bag / rubber.

2 Find and circle.

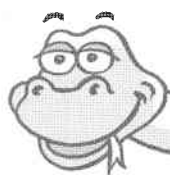

bagpencilcasepenrubbernotebookdesk

3 Read and match.

pencil

octopus

rubber

desk

umbrella

apple

bag

elephant

notebook

insect

a

an

4 Look and write.

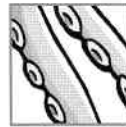

1 What's this?
It's a pencil.

2 What's this?
It's _____.

3 What's this?
It's _____.

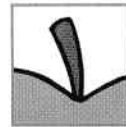







4 What's this?
It's _____.

5 What's this?
It's _____.

6 What's this?
It's _____.

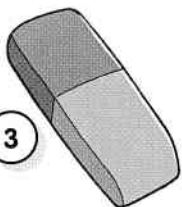
Spell 'octopus'

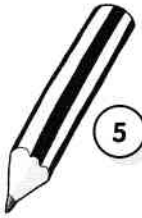
1 Look and match.

bag		2		4	pen
notebook		3		6	rubber
board		5			desk
pencil		1			chair
ruler					

2 What's missing in 1? Draw and write.

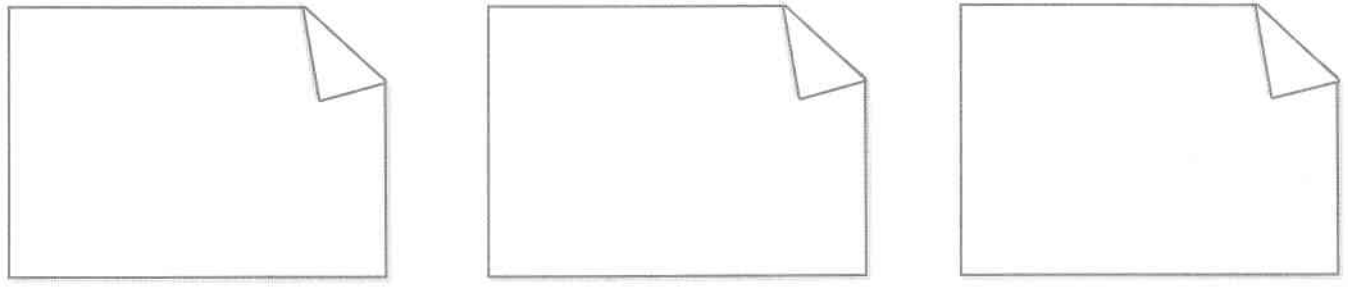

1 _____ **2** _____ **3** _____

3 Look and match.

a		b		c		d	
----------	---	----------	---	----------	--	----------	---

- | | | | |
|----------------------------|-----------------------------------|-------------------------------|-------------------------------|
| 1 Be quiet, please. | 2 Clean the board, please. | 3 Spell 'dog', please. | 4 Write 'cat', please. |
|----------------------------|-----------------------------------|-------------------------------|-------------------------------|

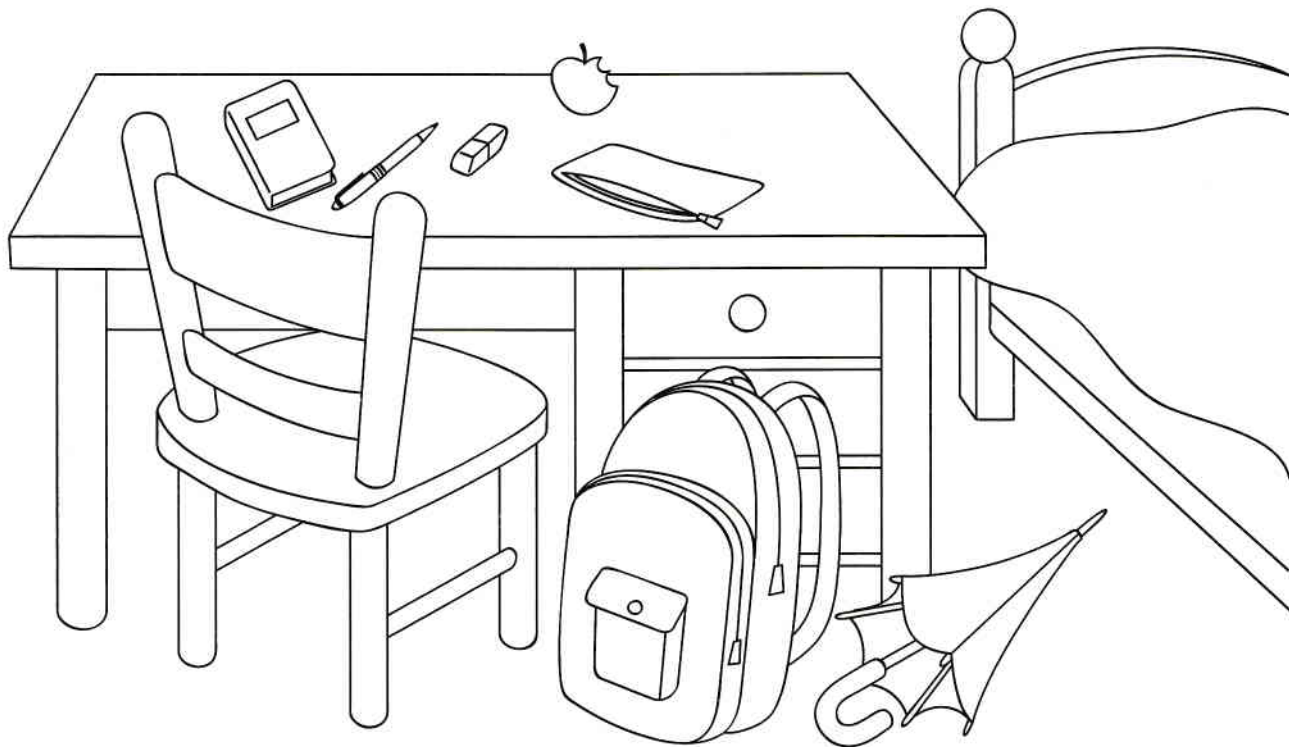
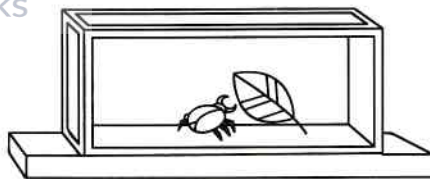

5 Read and circle. Then colour.

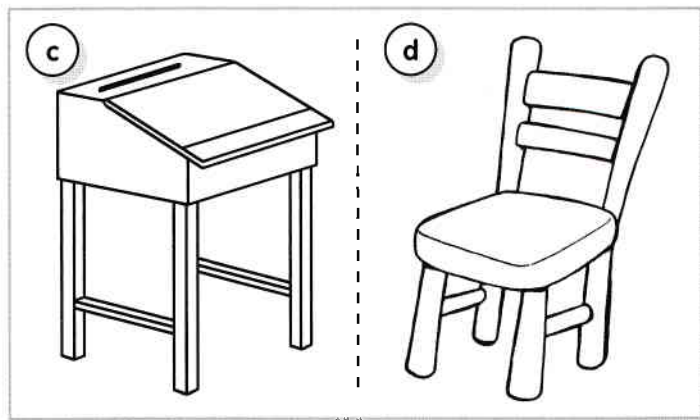
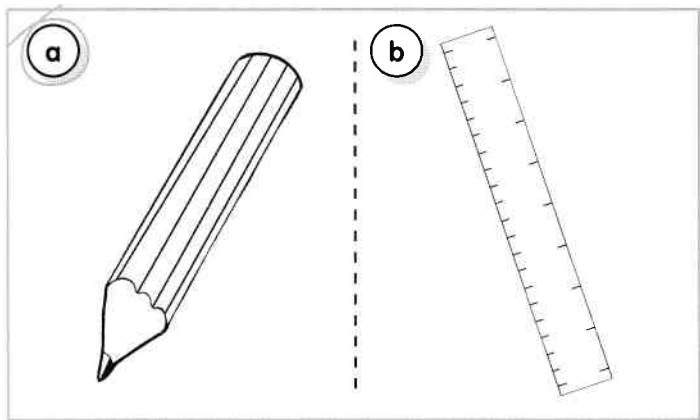

1 What's this?
It's a pencil.
What colour is it?
It's pink and grey.

2 What's this?
It's a chair.
What colour is it?
It's brown and green.